

STEREO DOUBLE CASSETTE DECK
CT-201/KXF-W1010
 SERVICE MANUAL

KENWOOD

© 1998-04/B51-5423-00 (K/K) 3162

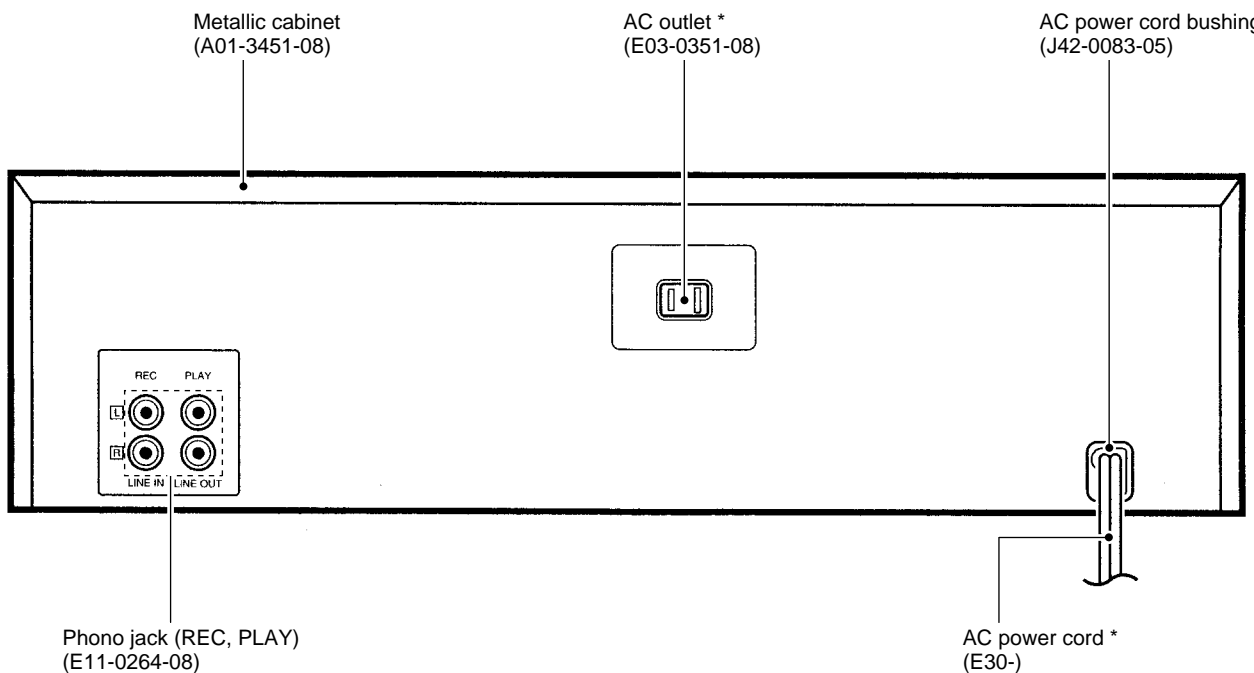
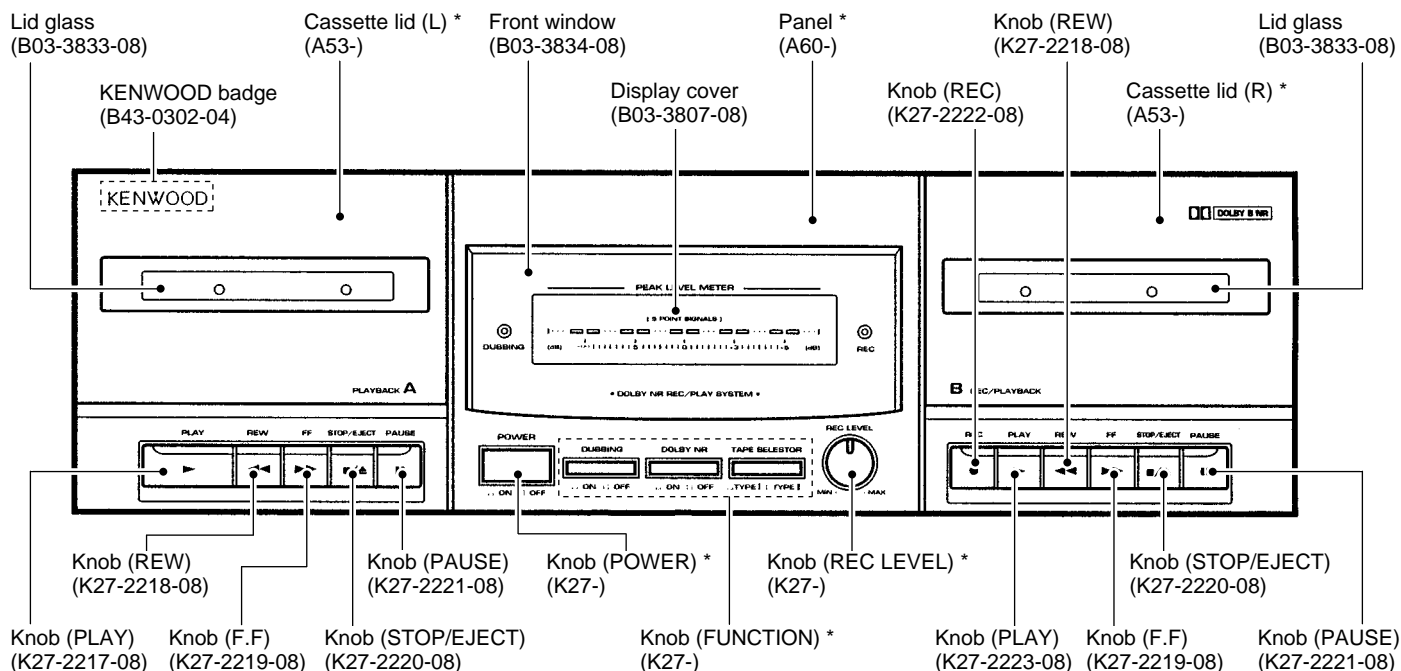

* Refer to parts list on page 12.



CT-201/KXF-W1010

CONTENTS/ACCESSORIES/CAUTION

Contents

CONTENTS/ACCESSORIES/CAUTION	2	EXPLODED VIEW	9
ADJUSTMENT	3	PARTS LIST	12
PC BOARD	5	PARTS DESCRIPTIONS	15
SCHEMATIC DIAGRAM	7	SPECIFICATIONS.. ..	Back cover

* Please refer to KX-W594/W1060 Service Manual (B51-4924-00) if you want to know disassembly and mechanism operation.

Accessories

Audio cord2
(E30-0615-05)

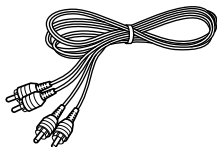

AC plug adaptor.....1
(E03-0115-05)

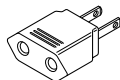

(Except for Europe and Australia)
For the unit with a European AC plug in
areas other than Europe

Caution

Beware of condensation

When water vapor comes into contact with the surface of cold material, water drops are produced. If condensation occurs, correct operation may not be possible, or the unit may not function correctly. This is not a malfunction, however, and the unit should be dried. (To do this, turn the POWER switch ON and leave the unit for several hours.)

Be especially careful in the following conditions:

- * When the unit is brought from a cold place to a warm place, and there is a large temperature difference.
- * When a heater starts operating.
- * When the unit is brought from an air-conditioned place to a place of high temperature with high humidity
- * When there is a large difference between the internal temperature of the unit and the ambient temperature, or in conditions where condensation occurs easily

CT-201/KXF-W1010

ADJUSTMENT

No.	ITEM	INPUT SETTINGS	OUTPUT SETTINGS	CASSETTE DECK SETTINGS	ALIGNMENT POINT	ALIGN FOR	FLG.
CASSETTE DECK SECTION		TAPE: NORMAL, DOLBY: OFF, INPUT: LINE IN			0 dBs = 0.775 V		
I. REC/PLAY HEAD							
[1]	DEMAGNETIZATION	-	-	POWER OFF Remove the cassette door.	REC/PLAY head	Demagnetize the REC/PLAY head with a head demagnetizer.	
[2]	CLEANING	-	-	PLAY	REC/PLAY head, erase head, capstan pinch roller	Clean the REC/PLAY head, erase head, capstan and pinch roller using a cotton swab slightly dampened with alcohol.	
[3]	AZIMUTH	(A) MTT-114, TCC-153 0 kHz, -10 dB	(B)	PLAY	Azimuth adjustment screw	Maximum output.	(a)
II. DC BOARD							
[1]	TAPE SPEED	(A) MTT-111, TCC-110 3 kHz	(B)	PLAY	Timing potentiometer in the DC motor.	Adjust the tape speed so that a 3 kHz signal is produced at the center of the tape.	(b)
III. PC BOARD							
< 1 >	PLAYBACK LEVEL	MTT-150 400 Hz (200 nWb)	(B)	PLAY	DECK A SFR101 (L) SFR102 (R)	Output level : -1 dBs	
		MTT-256 315 Hz (160 nWb)			DECK B SFR103 (L) SFR104 (R)	Output level : -4 dBs	
		MTT-256U, TCC-160 315 Hz (250 nWb)				Output level : 0 dBs	
< 2 >	LEDLEVEL	MTT-256U, TCC-160 315 Hz (250 nWb)	(B)	PLAY	SFR109 (L)	Adjust the variable resistors so that LED level of 0 dBs is worked.	
< 3 >	BIAS CURRENT	(A) 1 kHz, -20 dBs 10 kHz, -20 dBs	(B)	Adjust REC level VR so that the REC monitor output becomes -20 dBs at 1 kHz, then record and reproduce signal of 1 kHz and 10 kHz in alternation.	SFR107 (L) SFR108 (R)	Record 1 kHz and 10 kHz in alternation and adjust the variable resistors which control the bias current so that the same playback level is obtained.	
< 4 >	RECORD LEVEL	(A) 1 kHz, -20 dBs	(B)	Record and reproduce a 1 kHz, signal under the conditions set in < 3 >.	SFR105 (L) SFR106 (R)	Adjust the variable resistors so that LED level of 20 dBs is worked.	

CT-201/KXF-W1010

ADJUSTMENT

SYSTEM CONNECTIONS

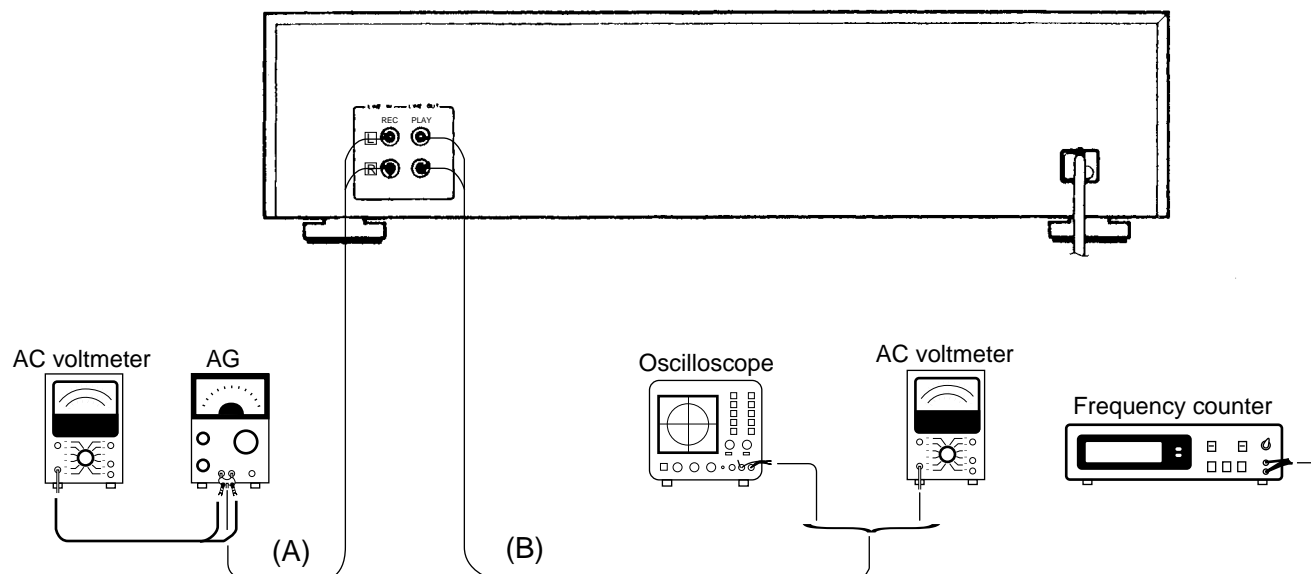

(a) AZIMUTH

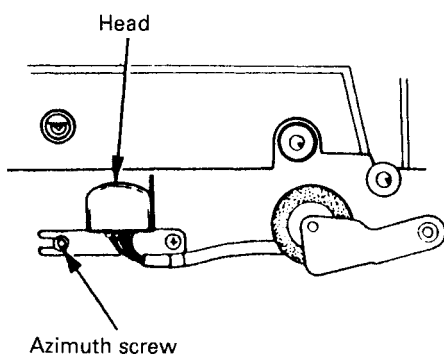

(b) TAPE SPEED

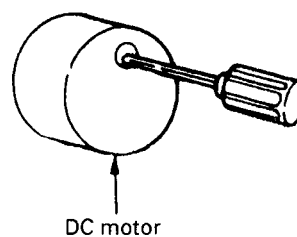

PC BOARD(Component side view)

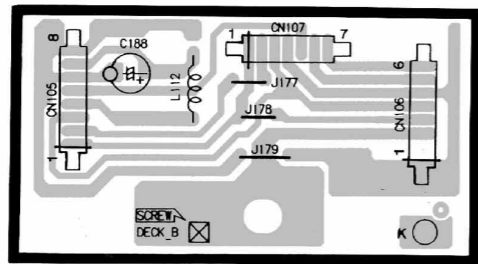
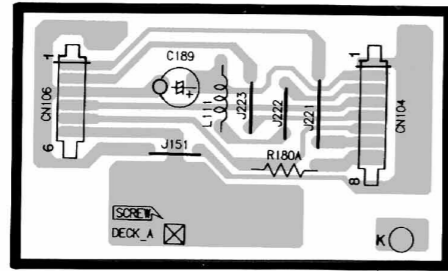
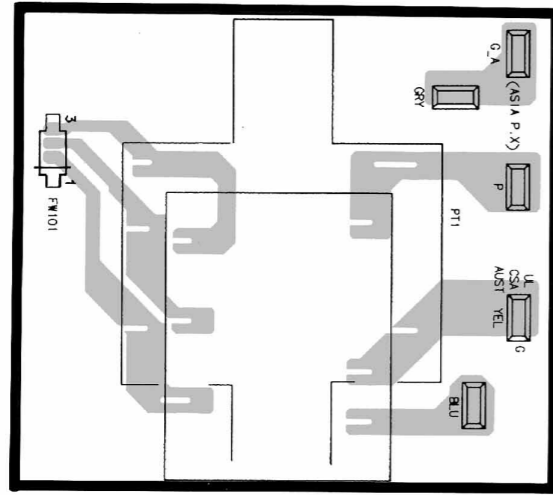

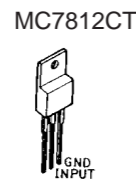
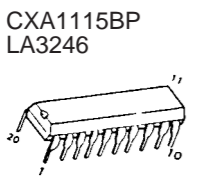
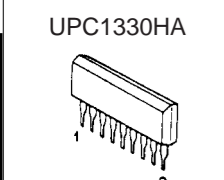
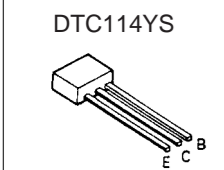
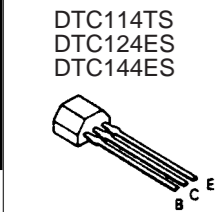
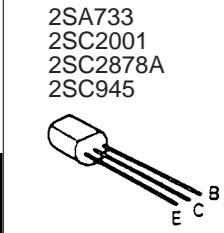
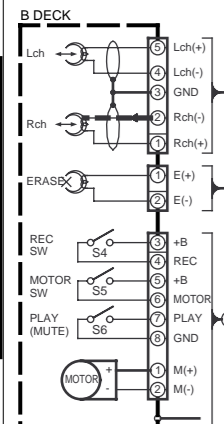
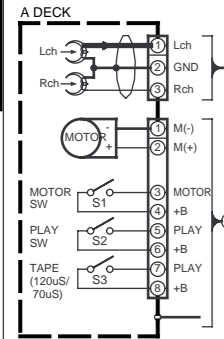
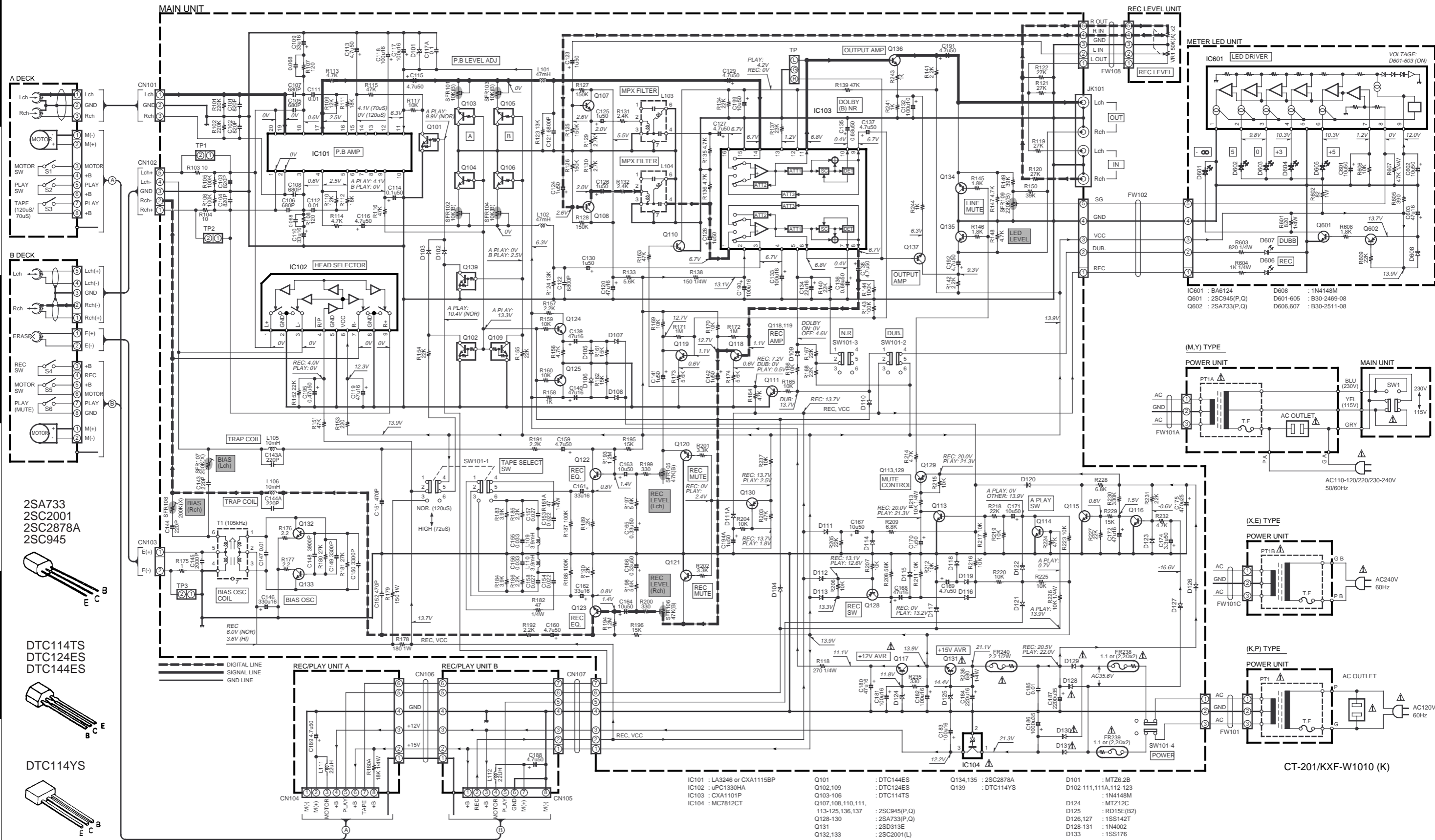

2SA733
2SC2001
2SC2878A
2SC945

DTC114TS
DTC124ES
DTC144ES

DTC114YS

UPC1330HA

CXA1115BP
LA3246

MC7812CT

IC101 : LA3246 or CXA1115BP
IC102 : uPC1330HA
IC103 : CXA11101P
IC104 : MC7812CT

Q101 : DTC144ES
Q102,109 : DTC124ES
Q103-106 : DTC114TS
Q107,108,110,111,113-125,136,137 : 2SC945(P,Q)
Q128-130 : 2SA733(P,Q)
Q131 : 2SD313E
Q132,133 : 2SC2001(L)

Q134,135 : 2SC2878A
Q139 : DTC114YS

D101 : MT26.2B
D102-111,111A,112-123 : 1N4148M
D124 : MT1212C
D125 : RD15E(B2)
D128,127 : 1SS142T
D128-131 : 1N4002
D133 : 1SS176

CAUTION: For continued safety, replace safety critical components only with manufacturer's recommended parts (refer to parts list). indicates safety critical components. For continued protection against risk of fire, replace only with same type and rating fuse(s). To reduce the risk of electric shock, leakage-current or resistance measurements shall be carried out (exposed parts are acceptably insulated from the supply circuit) before the appliance is returned to the customer.

The DC voltage is an actual reading measured with a high impedance type voltmeter with a cassette loaded at playback mode. The measurement value may vary depending on the measuring instruments used or on the product. Bias circuit DC voltage is measured while in the record mode.

DOLBY and the double-D symbol are trademarks of Dolby Laboratories Licensing Corporation. Noise reduction circuit made under license from Dolby Laboratories Licensing Corporation.

CT-201/KXF-W1010

Y26-4400-10

KENWOOD

CT-201/KXF-W1010

EXPLODED VIEW (DECK MECHANISM : A)

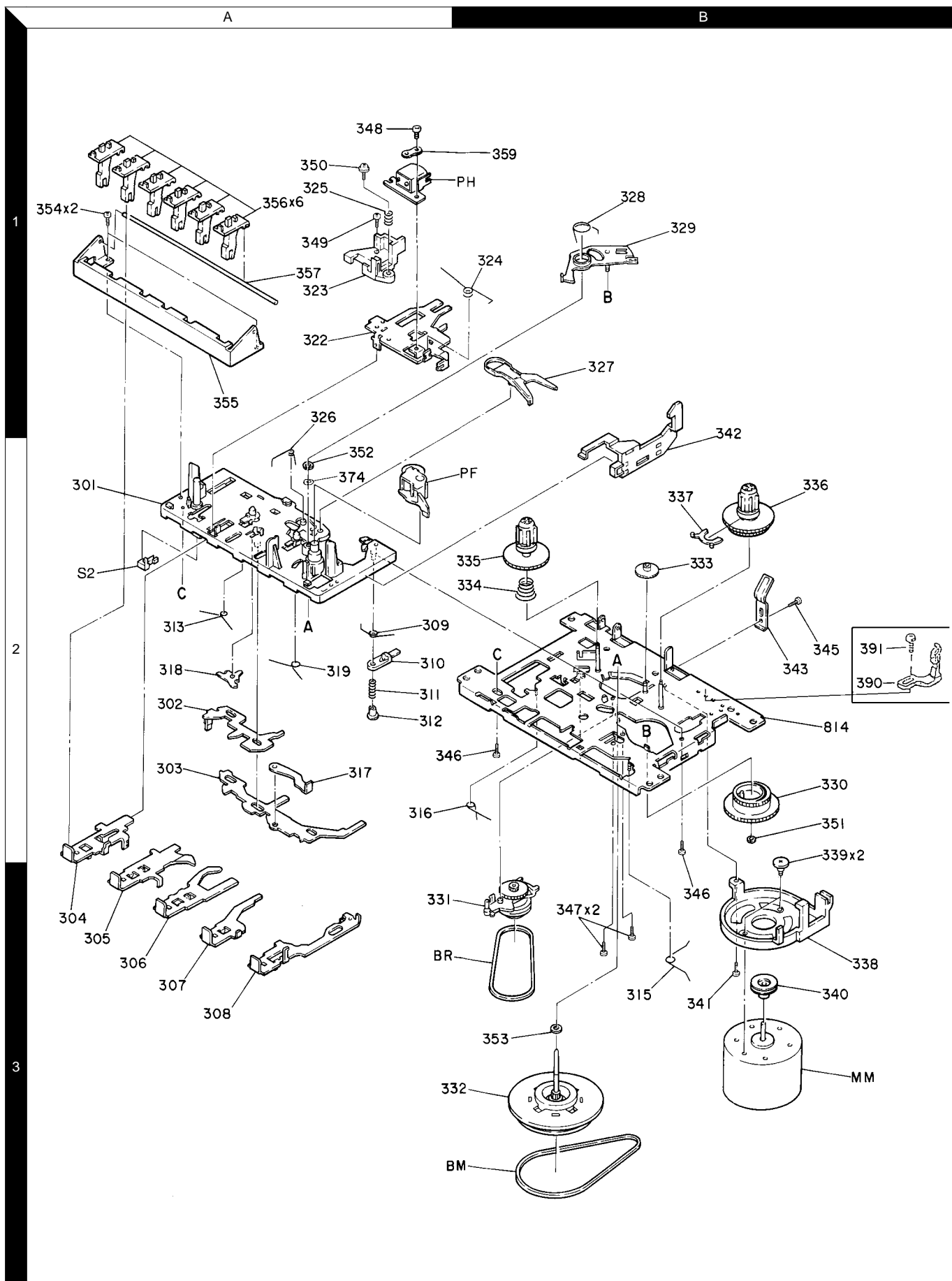

Parts with exploded numbers larger than 700 are not supplied.

CT-201/KXF-W1010

EXPLODED VIEW (DECK MECHANISM : B)

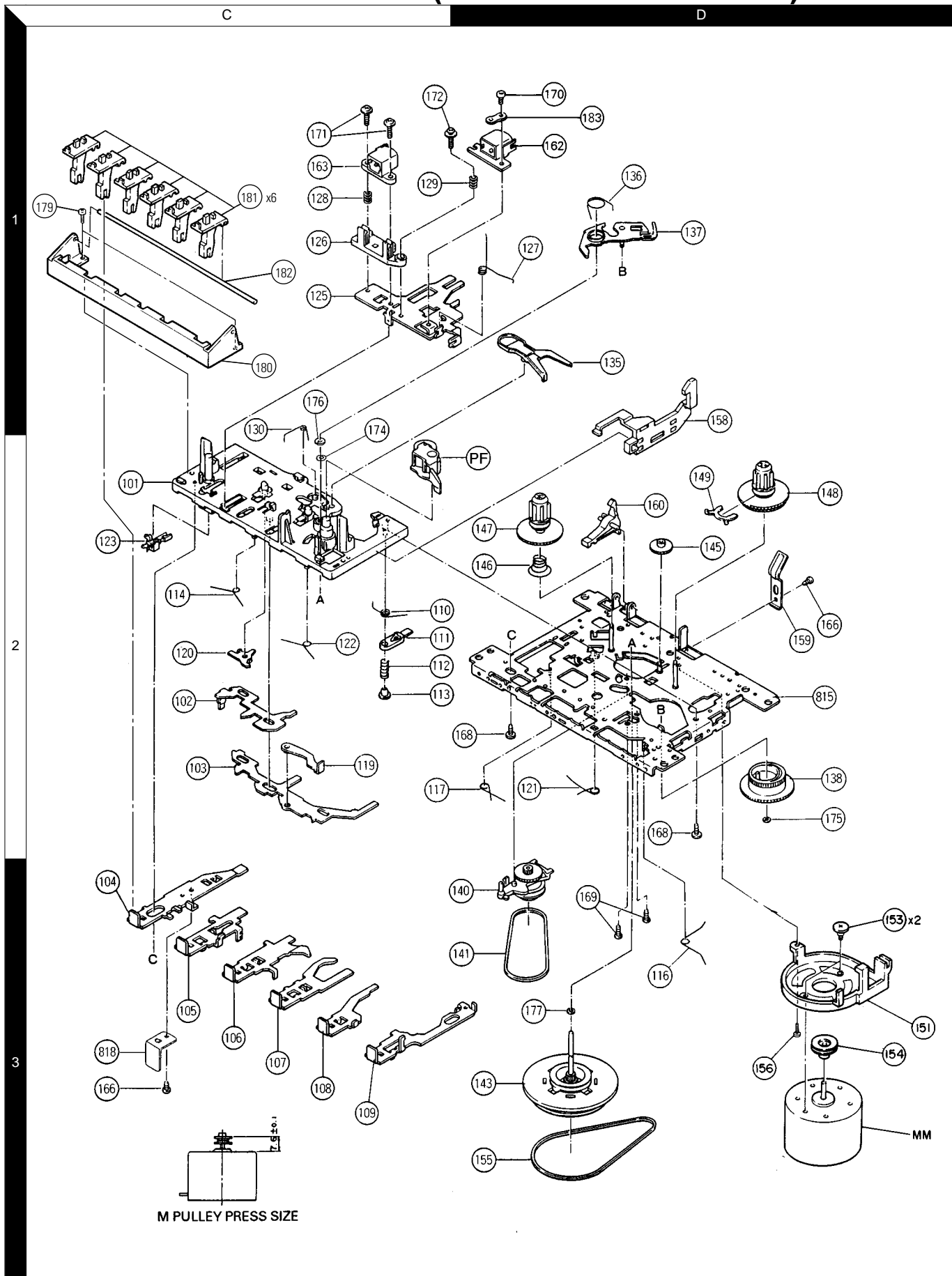

CT-201/KXF-W1010

EXPLODED VIEW (UNIT)

CT-201/KXF-W1010

- | | | |
|---|-------------|---------------|
| A | φ 3x6 (BLK) | : N89-3006-45 |
| B | φ 3x8 (BLK) | : N89-3008-45 |
| C | φ 3x8 | : N89-3008-46 |
| D | M2x8 | : N84-2008-46 |
| E | φ 3x6 | : N90-3006-46 |
| F | M4x6 | : N90-4010-46 |
| G | φ 3x8 | : N09-3216-08 |
| H | Push Rivet | : N29-1285-05 |

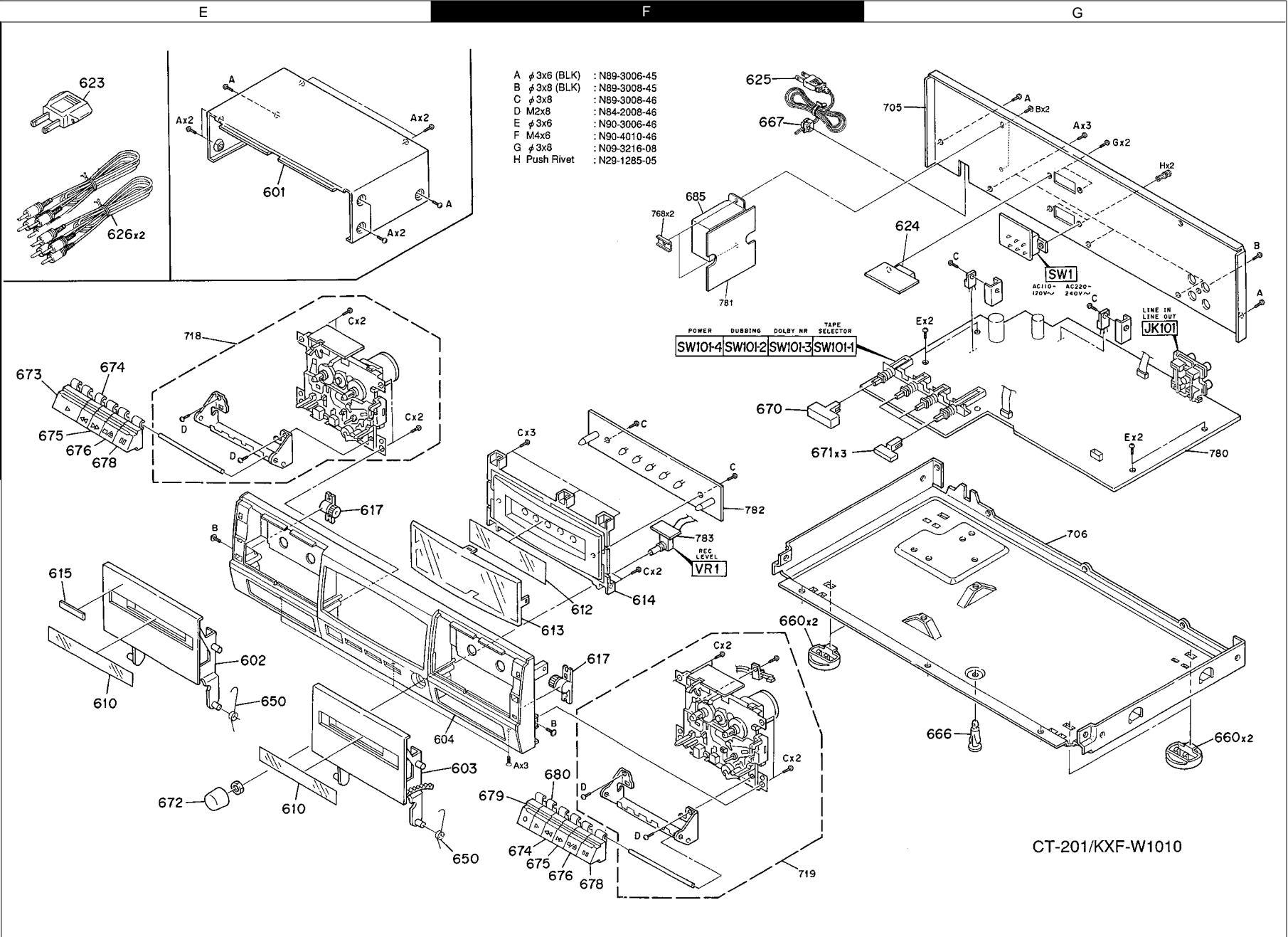

Parts with exploded numbers larger than 700 are not supplied.

* New Parts
Parts without **Parts No.** are not supplied.
Les articles non mentionnés dans le **Parts No.** ne sont pas fournis.
Teile ohne **Parts No.** werden nicht geliefert.

1

Ref. No	Add-ress	New Parts	Parts No.	Description	Desti-nation	Re-marks
CT-201/KXF-W1010 (A: A MECHANISM, B: B MECHANISM)						
601	1E		A01-3451-08	METALLIC CABINET		
602	2E	*	A53-2078-08	CASSETTE LID (L)	KP	
602	2E	*	A53-2079-08	CASSETTE LID (L)	MXEY	
603	2F	*	A53-2075-08	CASSETTE LID (R)	KP	
603	2F	*	A53-2076-08	CASSETTE LID (R)	MXEY	
604	2F	*	A60-1504-08	PANEL	KP	
604	2F	*	A60-1505-08	PANEL	MXEY	
610	2E	*	B03-3833-08	LID GLASS		
612	2F	*	B03-3807-08	DISPLAY COVER		
613	2F	*	B03-3834-08	FRONT WINDOW		
615	2E		B43-0302-04	KENWOOD BADGE		
-			B46-0092-33	WARRANTY CARD	K	
-			B46-0094-03	WARRANTY CARD	Y	
-			B46-0095-03	WARRANTY CARD	Y	
-			B46-0096-43	WARRANTY CARD	X	
-			B46-0121-33	WARRANTY CARD	P	
-		*	B60-3735-08	INSTRUCTION MANUAL (ENGLISH)	MX	
-		*	B60-3736-08	INSTRUCTION MANUAL (SPANISH)	M	
-		*	B60-3737-08	INSTRUCTION MANUAL (CHINA)	M	
-		*	B60-3738-08	INSTRUCTION MANUAL (CHI/TAIWA)	M	
-		*	B60-3739-08	INSTRUCTION MANUAL (ITALY)	E	
-		*	B60-3740-08	INSTRUCTION MANUAL (FRENCH)	P	
617	2E,2F		D39-0325-08	DAMPER ASSY		
Δ 623	1E		E03-0115-05	AC PLUG ADAPT	M	
Δ 624	1G		E03-0351-08	AC OUTLET	KPY	
Δ 625	1F		E30-0459-05	AC POWER CORD	ME	
Δ 625	1F		E30-0812-05	AC POWER CORD	Y	
Δ 625	1F		E30-0996-05	AC POWER CORD	KP	
Δ 625	1F		E30-2714-05	AC POWER CORD	X	
626	1E		E30-0615-05	AUDIO CORD		
-			F09-0093-08	PROTECTION SHEET (PACKING)		
650	2E,2F		G01-4011-08	CASSETTE HOLDER SPRING		
-		*	H10-7480-08	POLYSTYRENE FOAMED FIXTURE(L)		
-		*	H10-7481-08	POLYSTYRENE FOAMED FIXTURE(R)		
-			H25-1527-08	PROTECTION BAG		
-			H25-1533-08	PROTECTION BAG		
-		*	H50-2866-08	ITEM CARTONBOX	KP	
-		*	H50-2867-08	ITEM CARTONBOX	MXEY	
660	2F,2G	*	J02-1424-08	FOOT	KP	
660	2F,2G	*	J02-1425-08	FOOT	MXEY	
666	2G		J39-1001-08	SPACER SUPPORT		
Δ 667	1F		J42-0083-05	AC CORD BUSHING		
670	1F	*	K27-2301-08	KNOB POWER ,BLK	KP	
670	1F	*	K27-2302-08	KNOB POWER	MXEY	
671	1F	*	K27-2303-08	KNOB FUNCTION	KP	
671	1F	*	K27-2304-08	KNOB FUNCTION	MXEY	
672	2E	*	K27-2305-08	KNOB REC LEVEL	KP	
672	2E	*	K27-2306-08	KNOB REC LEVEL	MXEY	

L : Scandinavia K : USA P : Canada R : Mexico C : China I : Malaysia
Y : PX(Far East, Hawaii) T : Europe E : Europe G : Germany V : China (Shanghai)
Y : AAFES(Europe) X : Australia Q : Russia H : Korea M : Other Areas Δ indicates safety critical components.

12

* New Parts
Parts without **Parts No.** are not supplied.
Les articles non mentionnés dans le **Parts No.** ne sont pas fournis.
Teile ohne **Parts No.** werden nicht geliefert.

2

Ref. No	Add-ress	New Parts	Parts No.	Description	Desti-nation	Re-marks
673	1E		K27-2217-08	KNOB PLAY		A
674	1E,2F		K27-2218-08	KNOB REW		
675	1E,2F		K27-2219-08	KNOB F.F		
676	1E,2F		K27-2220-08	KNOB STOP/EJECT		
678	1E,2F		K27-2221-08	KNOB PAUSE		
679	2F		K27-2222-08	KNOB REC		B
680	2F		K27-2223-08	KNOB PLAY		B
Δ 685	1F	*	L07-2611-08	TRANSFORMER	KP	
Δ 685	1F	*	L07-2612-08	TRANSFORMER	YM	
Δ 685	1F	*	L07-2613-08	TRANSFORMER	XE	
G			N09-3216-08	SCREW (3X8)	YM	
ELECTRIC PARTS						
D601-605			B30-2469-08	LED,LEVEL METER		
D606,607			B30-2511-08	LED,DUBB		
C101-104			C91-0756-05	CERAMIC	820PF	K
C105-108			C91-0755-05	CERAMIC	680PF	K
C109,110			CE04KW1C330M	ELECTRO	33UF	16WV
C111,112			CQ92FM1H103J	MYLAR	0.010UF	J
C113			CE04KW1H4R7M	ELECTRO	4.7UF	50WV
C114			CE04KW1HR10M	ELECTRO	0.10UF	50WV
C115,116			CE04KW1H4R7M	ELECTRO	4.7UF	50WV
C117,118			CE04KW1C101M	ELECTRO	100UF	16WV
C117A			C91-1525-08	CERAMIC	0.1UF	Z
C119,120			CE04KW1C470M	ELECTRO	47UF	16WV
C121,122			CQ92FM1H682J	MYLAR	6800PF	J
C123-130			CE04KW1H010M	ELECTRO	1.0UF	50WV
C132			CE04KW1A101M	ELECTRO	100UF	10WV
C133			CE04KW1C101M	ELECTRO	100UF	16WV
C134			CE04KW1C220M	ELECTRO	22UF	16WV
C135,136			CE04KW1HR68M	ELECTRO	0.68UF	50WV
C137,138			CE04KW1E4R7M	ELECTRO	4.7UF	25WV
C139,140			CE04KW1C470M	ELECTRO	47UF	16WV
C141,142			CE04KW1H010M	ELECTRO	1.0UF	50WV
C144,144A			CC45FSL1H221J	CERAMIC	220PF	J
C145			CQ93HP2A202J	MYLAR	2000PF	J
C146			CE04KW1C331M	ELECTRO	330UF	16WV
C147			CQ92FM1H103J	MYLAR	0.010UF	J
C148			CQ92FM1H392J	MYLAR	3900PF	J
C149,150			CQ92FM1H332J	MYLAR	3300PF	J
C151,152			C91-1524-08	CERAMIC	470PF	K
C153,154			CQ92FM1H223J	MYLAR	0.022UF	J
C155,156			CQ92FM1H333J	MYLAR	0.033UF	J
C157,158			CQ92FM1H273J	MYLAR	0.027UF	J
C159,160			CE04KW1E4R7M	ELECTRO	4.7UF	25WV
C161,162			CE04KW1C330M	ELECTRO	33UF	16WV
C163,164			CE04KW1H100M	ELECTRO	10UF	50WV
C165,166			CE04KW1HR33M	ELECTRO	0.33UF	50WV
C167			CE04KW1H100M	ELECTRO	10UF	50WV
C168			CE04KW1C470M	ELECTRO	47UF	16WV
C169			CE04KW1E4R7M	ELECTRO	4.7UF	25WV
C170			CE04KW1H010M	ELECTRO	1.0UF	50WV
C171			CE04KW1H100M	ELECTRO	10UF	50WV
C172			CE04KW1C470M	ELECTRO	47UF	16WV

L : Scandinavia K : USA P : Canada R : Mexico C : China I : Malaysia
Y : PX(Far East, Hawaii) T : Europe E : Europe G : Germany V : China (Shanghai)
Y : AAFES(Europe) X : Australia Q : Russia H : Korea M : Other Areas Δ indicates safety critical components.

PARTS LIST

CT-201/KXF-W1010

* New Parts
Parts without **Parts No.** are not supplied.
Les articles non mentionnés dans le **Parts No.** ne sont pas fournis.
Teile ohne **Parts No.** werden nicht geliefert.

3

Ref. No	Add-ress	New Parts	Parts No.	Description	Desti-nation	Re-marks
C174			CE04KW1H3R3M	ELECTRO 3.3UF 50WV		
C175			CE04KW1E471M	ELECTRO 470UF 25WV		
C180			CE04KW1C470M	ELECTRO 47UF 16WV		
C181-183			CE04KW1C101M	ELECTRO 100UF 16WV		
C184			CE04KW1C221M	ELECTRO 220UF 16WV		
C185			CK45FF1H103Z	CERAMIC 0.010UF Z		
C186			CE04KW1V102M	ELECTRO 1000UF 35WV		
C187			CE04KW1V222M	ELECTRO 2200UF 35WV		
C188,189			CE04KW1H4R7M	ELECTRO 4.7UF 50WV		
C190			CE04KW1C101M	ELECTRO 100UF 16WV		
C191,192			CE04KW1H4R7M	ELECTRO 4.7UF 50WV		
C194A			CE04KW1H010M	ELECTRO 1.0UF 50WV		
C195			CE04KW1HR47M	ELECTRO 0.47UF 50WV		
C199			CE04KW1H100M	ELECTRO 10UF 50WV		
C601,602			CE04KW1H100M	ELECTRO 10UF 50WV		
C603			CE04KW1C470M	ELECTRO 47UF 16WV		
CN101			E40-3261-05	PH,3P, TOP BASE		
CN102			E40-3263-05	PH,5P, TOP BASE		
CN103			E40-3260-05	PIN ASSY,PH,CN,2P		
CN107			J19-5809-08	FTW,7P, TOP BASE		
JK101	1G		E11-0264-08	PHONO JACK (REC,PLAY)		
CN105			J19-5640-08	WIRE HOLDER,8P		
CN106			J19-5810-08	WIRE HOLDER,6P		
CN107			J19-5811-08	WIRE HOLDER,7P		
L101,102			L39-1340-08	INDUCTOR		
L103,104			L39-1329-08	MPX FILTER		
L105,106			L40-1035-29	TRAP COIL 10MH		
L109,110			L40-3925-29	TRAP COIL 3.9MH		
L111,112			L39-1332-08	PEAKING COIL 22UH		
T1			L32-0598-08	BIAS OCS COIL		
Δ FR238-240			R92-1772-08	FUSE RESISTOR 2.2 1/2W		
R118			RS14KB3A271J	FL-PROOF RS 270 J 1W		
R178			RS14KB3A181J	FL-PROOF RS 180 J 1W		
R179			RS14KB3A151J	FL-PROOF RS 150 J 1W		
R602			RS14KB3A820J	FL-PROOF RS 82 J 1W		
SFR101-4			R32-0006-08	TRIM POT(10K) PB LEVEL ADJ.		
SFR105.6			R32-0007-08	TRIM POT(50K) REC LEVEL ADJ.		
SFR107-9			R32-0008-08	TRIM POT(200K)		
VR1	2F		R31-0088-08	TRIM POT(50KX2) REC LEVEL		
Δ SW1	1G		S90-0124-08	SLID SWITCH(120V/240V)	YM	
SW101	1F	*	S68-0103-08	PUSH SWITCH(DOLBY/DUBB./TAPE)		
D101			MTZ6.2B	ZENER DIODE		
D102-123			1N4148M	DIODE		
D124			MTZ12C	ZENER DIODE		
D125			RD15E(B2)	ZENER DIODE		
D126,127			1SS142T	DIODE		
Δ D128-131			1N4002	DIODE		
D133			1SS176	DIODE		
D608			1N4148M	DIODE		
IC101			CXA1115BP	IC(PLAY/BACK AMP)		
IC101			LA3246	IC(PREAMP X2)AMP)		
IC102			UPC1330HA	IC(2CH HEAD SWITCHING)		

L: Scandinavia K: USA P: Canada R: Mexico C: China I: Malaysia
Y: PX(Far East, Hawaii) T: Europe E: Europe G: Germany V: China (Shanghai)
Y: AAFES(Europe) X: Australia Q: Russia H: Korea M: Other Areas Δ indicates safety critical components.

* New Parts
Parts without **Parts No.** are not supplied.
Les articles non mentionnés dans le **Parts No.** ne sont pas fournis.
Teile ohne **Parts No.** werden nicht geliefert.

4

Ref. No	Add-ress	New Parts	Parts No.	Description	Desti-nation	Re-marks
Δ IC103			CXA1101P	IC(DOLBY B)		
Δ IC104			MC7812CT	IC(VOLTAGE REGULATOR/ +12V))		
Δ IC104			NJM7812A	IC(+12V AVR)		
IC601			BA6124	IC(LED DRIVER)		
Q101			DTC144ES	TRANSISTOR		
Q102			DTC124ES	TRANSISTOR		
Q103-106			DTC114TS	TRANSISTOR		
Q107,108			2SC945(P,Q)	TRANSISTOR		
Q109			DTC124ES	TRANSISTOR		
Q110,111			2SC945(P,Q)	TRANSISTOR		
Δ Q113-125			2SC945(P,Q)	TRANSISTOR		
Δ Q128-130			2SA733(P,Q)	TRANSISTOR		
Δ Q131			2SD313E	TRANSISTOR		
Q132,133			2SC2001(L)	TRANSISTOR		
Q134,135			2SC2878A	TRANSISTOR		
Q136,137			2SC945(P,Q)	TRANSISTOR		
Q139			DTC114YS	TRANSISTOR		
Q601			2SC945(P,Q)	TRANSISTOR		
Q602			2SA733(P,Q)	TRANSISTOR		
A MECHANISM						
301	2A		TN-192114301	BASE ASSY		
302	2A		TN-19211409	SWITCH ACTUATOR		
303	2A		TN-19211408	PUSH BUTTON ACTUATOR		
304	3A		TN-19211423	PLAY BUTTON LEVER		
305	3A		TN-19211424	REW BUTTON LEVER		
306	3A		TN-19211425	FF BUTTON LEVER		
307	3A		TN-19211426	STOP BUTTON LEVER		
308	3A		TN-19211461	PAUSE BUTTON LEVER		
309	2A		TN-19211413A	P CONTROL SPRING		
310	2A		TN-19211455	PAUSE LEVER		
311	2A		TN-19211412	PAUSE LEVER SPRING		
312	2A		TN-19211411	FRUSE STOPPER		
313	2A		TN-19211414	BUTTON LEVER SPRING(A)		
315	3B		TN-19211416	E ACTUATOR SPRING		
316	2A		TN-19211417	P.S.LEVER SPRING		
317	2A		TN-182101159	E KICK LEVER		
318	2A		TN-19211420	PR STOPPER		
319	2A		TN-19211415	BUTTON LEVER SPRING(B)		
322	1A		TN-19210311	HEAD PANEL		
323	1A		TN-19210304A	HEAD BASE		
324	1B		TN-19210309	PANEL P SPRING		
325	1A		TN-18210307	AZIMUTH SPRING		
326	2A		TN-19211418A	M CONTROL SPRING		
327	1B		TN-19212604A	SENSING LEVER		
328	1B		TN-19212605	GEAR PLATE SPRING		
329	1B		TN-192126501	GEAR PLATE ASSY		
330	2B		TN-19212602	CAM GEAR		
331	3A		TN-192107304	RF CLUTCH ASSY		
332	3A		TN-192109303	FLYWHEEL ASSY		
333	2B		TN-18211070	FF GEAR		
334	2B		TN-18291099	BACK TENSION SPRING		
335	2B		TN-192105306	SUPPLY REEL ASSY		
336	2B		TN-192105305	TAKE UP REEL ASSY		
337	2B		TN-19210506	SENER		
338	3B		TN-18211289A	MOTOR BRACKET		

L: Scandinavia K: USA P: Canada R: Mexico C: China I: Malaysia
Y: PX(Far East, Hawaii) T: Europe E: Europe G: Germany V: China (Shanghai)
Y: AAFES(Europe) X: Australia Q: Russia H: Korea M: Other Areas Δ indicates safety critical components.

* New Parts
Parts without **Parts No.** are not supplied.
Les articles non mentionnés dans le **Parts No.** ne sont pas fournis.
Teile ohne **Parts No.** werden nicht geliefert.

5

Ref. No	Add-ress	New Parts	Parts No.	Description	Desti-nation	Re-marks
339	3B		TN-19211202	MOTOR COLLAR SCREW		
340	3B		TN-19211201	MOTOR PULLEY		
341	3B		TN-19211203	MB SCREW		
342	2B		TN-19211302	EJECT SLIDE LEVER		
343	2B		TN-18291001	PACK SPRING		
345	2B		TN-9P3320032	C TAPPING SCREW M2X3		
346	2A,3B		TN-96790000	P TAPPING BIND SCREW M2X5		
347	3B		TN-99991809	TAPPING SCREW M2X4.5		
348	1A		N35-2003-46	#NAME?		
349	1A		TN-90040000	SCREW M2X6		
350	1A		TN-99220000	AZIMUTH SCREW M2X7		
351	1A		TN-94220000	P WASHER OUT 1.2X3.8X0.3		
352	2A		TN-99997001	P WASHER OUT 1.45X3.8X0.5		
353	3B		TN-98820000	P WASHER 2X3.5X0.4		
354	1A		TN-99991402	S TAPPING SCREW M2X8		
355	1A		TN-18213106	B FRAME(S)		
356	1A		TN-18213107	OPERATION LEVER		
357	1A		TN-18293103	BUTTON LEVER SHAFT		
359	1B		TN-98400000	B3 LUG PLATE		
374	2A		TN-99990003	P WASHER 2.1X4.0X0.13		
390	2B		TN-640101125	LEAF SWITCH		
391	2B		TN-96610000	SCREW M2X4		
BM	3A		TN-19210904	MAIN BELT		
BR	3A		TN-19210703	RF BELT		
MM	3B		TN-EG-530AD-2B	MOTOR		
PF	2A		TN-192104309	PINCH ROLLER ARM ASSY		
PH	1A		T31-0076-08	P.B.HEAD		
S1			TN-640101125	LEAF SWITCH (MOTOR SW)		
S2			TN-640101149	LEAF SWITCH(MSW-1541T)PLAY SW		
S3			S74-0039-08	LEAF SWITCH (TAPE SW)		
B MECHANISM						
101	2C		TN-192114301	BASE ASS.Y		
102	2C		TN-19211409	SWITCH ACTUATOR		
103	2C		TN-19211408	PUSH BUTTON ACTUATOR		
104	2C		TN-19211422	REC BUTTON LEVER		
105	3C		TN-19211423	PLAY BUTTON LEVER		
106	3C		TN-19211424	REW BUTTON LEVER		
107	3C		TN-19211425	FF BUTTON LEVER		
108	2C		TN-19211426	STOP BUTTON LEVER		
109	3C		TN-19211461	PAUSE BUTTON LEVER		
110	2C		TN-19211413A	P CONTROL SPRING		
111	2C		TN-19211455	PAUSE LEVER(E)		
112	2C		TN-19211412	PAUSE LEVER SPRING		
113	2C		TN-19211411	PAUSE STOPPER		
114	2C		TN-19211414	BUTTON LEVER SPRING(A)		
116	3D		TN-19211416	E ACTUATOR SPRING		
117	2C		TN-19211417	P.S.LEVER SPRING		
119	2C		TN-18210159	E KICK LEVER		
120	2C		TN-19211420	PR STOPPER		
121	2D		TN-19211421	REC BUTTON LEVER SPRING		
122	2C		TN-19211415	BUTTON LEVER SPRING(B)		
125	1C		TN-19210312	HEAD PANEL		
126	1C		TN-19210306	HEAD BASE		
127	1D		TN-19210309	PANEL P SPRING		

L : Scandinavia K : USA P : Canada R : Mexico C : China I : Malaysia
Y : PX(Far East, Hawaii) T : Europe E : Europe G : Germany V : China (Shanghai)
Y : AAFES(Europe) X : Australia Q : Russia H : Korea M : Other Areas Δ indicates safety critical components.

* New Parts
Parts without **Parts No.** are not supplied.
Les articles non mentionnés dans le **Parts No.** ne sont pas fournis.
Teile ohne **Parts No.** werden nicht geliefert.

5

Ref. No	Add-ress	New Parts	Parts No.	Description	Desti-nation	Re-marks
128	1C		TN-18210308	EH SPRING		
129	1C		TN-18210307	AZIMUTH SPRING		
130	1C		TN-19211418A	M CONTROL SPRING		
135	1D		TN-19212604A	SENSING LEVER		
136	1D		TN-19212605	GEAR PLATE SPRING		
137	1D		TN-192126501	GEAR PLATE ASSY		
138	2D		TN-19212602	CAM GEAR		
140	3C		TN-192107304	RF CLUTCH ASS'Y		
141	3C		TN-19210703	RF BELT		
143	3C		TN-192109303	FLYWHEEL ASS'Y		
145	2D		TN-18211070	FF GEAR		
146	2D		TN-18291099	BACK TENSION SPRING		
147	2D		TN-192105306	SUPPLY REEL ASS'Y		
148	2D		TN-192105305	TAKE UP REEL ASS'Y		
149	2D		TN-19210506	SENER		
151	3D		TN-18211289A	MOTOR BRACKET		
153	3D		TN-19211202	MOTOR COLLER SCREW		
154	3D		TN-19211201	MOTOR PULLEY		
155	3C		TN-19210904	MAIN BELT		
156	3D		TN-19211203	MB SCREW		
158	1D		TN-19211302	EJECT SLIDE LEVER		
159	2D		TN-18291001	PACK SPRING		
160	2D		TN-18211069	RECORD SAFETY LEVER		
162	1D		T34-0351-08	R.P.HEAD		
163	1C		T32-0331-08	E HEAD		
166	2D		TN-91790000	C TAPPING SCREW M2X3		
168	2C,2D		TN-96790000	P TAPPING BIND SCREW M2X5		
169	3D		TN-99991809	TAPPING SCREW(FOR CAMERA)M2X4.5		
170	1D		N35-2004-41	C TAPPING SCREW M2X4		
171	1C		TN-98210000	CAP SCREW M2X8		
172	1C		TN-99220000	AZIMUTH SCREW M2X7		
174	2C		TN-99990003	P WASHER 2.1X4.0X0.13		
175	2D		TN-94220000	P WASHER CUT 12X3.8X0.3		
176	1C		TN-99997001	P WASHER CUT 1.45X3.2X0.5		
177	3D		TN-98820000	P WASHER 2X3.5X0.3		
183	1D		TN-98400000	B3 LUG PLATE		
MM	3D		TN-EG-530AD-2B	MOTOR		
PF	1C		TN-192104309	PINCH ROLLER ARM ASSY		
S4			S74-0040-08	LEAF SWITCH (REC SW)		
S5			TN-640101125	LEAF SWITCH (MOTOR SW)		
S6	1F		S74-0039-08	LEAF SWITCH (MUTE)		

L : Scandinavia K : USA P : Canada R : Mexico C : China I : Malaysia
Y : PX(Far East, Hawaii) T : Europe E : Europe G : Germany V : China (Shanghai)
Y : AAFES(Europe) X : Australia Q : Russia H : Korea M : Other Areas Δ indicates safety critical components.

HOW TO READ THE PARTS LIST

ABBREVIATION OF MODEL AND MASS PRODUCTION'S DESTINATIONS

MODEL	ABB.	Australia	Canada	China	England	Europe	Germany	Korea	Malaysia
CT-201	-	-	P	-	-	-	-	-	-
KXF-W1010	-	X	-	-	-	E	-	-	-
MODEL	ABB.	Mexico	PX/AAFES	Russia	Scandinavia	Shanghai	U.S.A.	Other area	
CT-201	-	-	-	-	-	-	K	-	
KXF-W1010	-	-	Y	-	-	-	-	M	

CT-201/KXF-W1010

PARTS DESCRIPTIONS

CAPACITORS

CC 45 TH 1H 220 J
 1 2 3 4 5 6

- 1 = Type ... ceramic, electrolytic, etc.
- 2 = Shape ... round, square, ect.
- 3 = Temp. coefficient
- 4 = Voltage rating
- 5 = Value
- 6 = Tolerance

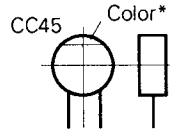

• Capacitor value

- 010 = 1pF
- 100 = 10pF
- 101 = 100pF
- 102 = 1000pF = 0.001μF
- 103 = 0.01μF

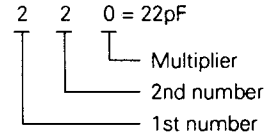

• Temperature coefficient

1st Word	C	L	P	R	S	T	U
Color*	Black	Red	Orange	Yellow	Green	Blue	Violet
ppm/°C	0	-80	-150	-220	-330	-470	-750

2nd Word	G	H	J	K	L
ppm/°C	±30	±60	±120	±250	±500

Example : CC45TH = -470 ± 60ppm/°C

• Tolerance (More than 10pF)

Code	C	D	G	J	K	M	X	Z	P	No code
(%)	±0.25	±0.5	±2	±5	±10	±20	+40 -20	+80 -20	+100 -0	More than 10μF -10 ~ +50 Less than 4.7μF -10 ~ +75

(Less than 10pF)

Code	B	C	D	F	G
(pF)	±0.1	±0.25	±0.5	±1	±2

• Voltage rating

2nd word \ 1st word	A	B	C	D	E	F	G	H	J	K	V
0	1.0	1.25	1.6	2.0	2.5	3.15	4.0	5.0	6.3	8.0	-
1	10	12.5	16	20	25	31.5	40	50	63	80	35
2	100	125	160	200	250	315	400	500	630	800	-
3	1000	1250	1600	2000	2500	3150	4000	5000	6300	8000	-

• Chip capacitors

(EX) C C 7 3 F S L 1 H 0 0 0 J
 1 2 3 4 5 6 7

(Chip) (CH, RH, UJ, SL)

(EX) C K 7 3 F F 1 H 0 0 0 Z
 1 2 3 4 5 6 7

(Chip) (B, F)

Refer to the table above.

- 1 = Type
- 2 = Shape
- 3 = Dimension
- 4 = Temp. coefficient
- 5 = Voltage rating
- 6 = Value
- 7 = Tolerance

Dimension (Chip capacitors)

Dimension code	L	W	T
Empty	5.6 ± 0.5	5.0 ± 0.5	Less than 2.0
A	4.5 ± 0.5	3.2 ± 0.4	Less than 2.0
B	4.5 ± 0.5	2.0 ± 0.3	Less than 2.0
C	4.5 ± 0.5	1.25 ± 0.2	Less than 1.25
D	3.2 ± 0.4	2.5 ± 0.3	Less than 1.5
E	3.2 ± 0.2	1.6 ± 0.2	Less than 1.25
F	2.0 ± 0.3	1.25 ± 0.2	Less than 1.25
G	1.6 ± 0.2	0.8 ± 0.2	Less than 1.0

RESISTORS

• Chip resistor (Carbon)

(EX) R K 7 3 E B 2 B 0 0 0 J
 1 2 3 4 5 6 7

(Chip) (B, F)

• Carbon resistor (Normal type)

(EX) R D 1 4 B B 2 C 0 0 0 J
 1 2 3 4 5 6 7

- 1 = Type
- 2 = Shape
- 3 = Dimension
- 4 = Temp. coefficient
- 5 = Rating wattage
- 6 = Value
- 7 = Tolerance

Dimension

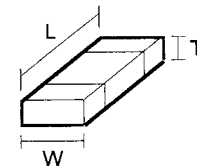

Dimension (Chip resistor)

Dimension code	L	W	T
E	3.2 ± 0.2	1.6 ± 0.2	1.0
F	2.0 ± 0.3	1.25 ± 0.2	1.0
G	1.6 ± 0.2	0.8 ± 0.2	0.5 ± 0.1

Rating wattage

Code	Wattage	Code	Wattage	Code	Wattage
1J	1/16W	2C	1/6W	3A	1W
2A	1/10W	2E	1/4W	3D	2W
2B	1/8W	2H	1/2W		

CT-201/KXF-W1010

SPECIFICATIONS

Track System 4 track, 2 channel stereo
Recording System AC bias (Frequency: 105 kHz)
Heads A DECK
 Playback heads 1
 B DECK
 Playback / recording heads 1
 Erasing head 1
Motors A DECK × 1
 B DECK × 1
Wow and Flutter 0.3 % (W.RMS)
Fast Winding Time Approx. 110 seconds (C-60 tape)
Frequency Response
 TYPE I Tape 30 Hz to 13,000 Hz, ± 3 dB
 TYPE II Tape 30 Hz to 13,000 Hz, ± 3 dB
Signal to Noise Ratio
 Dolby NR OFF 57 dB
 Dolby B NR ON 66 dB
 (3rd, H.D., 3 %, TYPE II Tape)
Input sensitivity / Impedance
 LINE IN 122.8 mV / 47 kΩ
Output Level / Impedance
 LINE OUT 775 mV / 3.3 kΩ

[General]

Power Consumption 14 W
AC outlets
 For the U.S.A. and Canada
 UN SWITCHED 1 (200W, 1.6A max.)
 For other countries
 UN SWITCHED 1 (200W, max.)
Dimensions W:440mm (17-5/16")
 H:133 mm (5-1/4")
 D:280 mm (11")
Weight (Net) 4.0 kg (8.8 lb)

Note :

We follow a policy of continuous advancements in development. For this reason specifications may be changed without notice.

Note:

Component and circuitry are subject to modification to insure best operation under differing local conditions. This manual is based on Europe (E) standard, and provides information on regional circuit modification through use of alternate schematic diagrams, and information on regional component variations through use of parts list.

KENWOOD CORPORATION

14-6, Dogenzaka 1-chome, Shibuya-ku, Tokyo, 150-8501 Japan

KENWOOD SERVICE CORPORATION

P.O. BOX 22745, 2201 East Dominguez St., Long Beach, CA 90801-5745, U.S.A.

KENWOOD ELECTRONICS CANADA INC.

6070 Kestrel Road, Mississauga, Ontario, Canada L5T 1S8

KENWOOD ELECTRONICS LATIN AMERICA S.A.

P.O. BOX 55-2791, Piso 6 plaza Chase, Cl. 47 y Aquilino de la Guardia Panama, Republic de Panama

KENWOOD ELECTRONICS BRASIL LTDA.

Av Indianópolis, 628, 04062-001 Planalto Paulista São Paulo-SP-Brasil

KENWOOD ELECTRONICS U.K. LIMITED

KENWOOD House, Dwight Road, Watford, Herts., WD1 8EB., United Kingdom

KENWOOD ELECTRONICS BELGIUM N.V.

Meachelsesteenweg 418, B-1930 Zaventem, Belgium

KENWOOD ELECTRONICS DEUTSCHLAND GMBH

Rembrücker Str. 15, 63150 Heusenstamm, Germany

KENWOOD ELECTRONICS FRANCE S.A.

13 Boulevard Ney, 75018 Paris, France

KENWOOD ELECTRONICS ITALIA S.p.A.

Via G. Sirtori, 7/9 20129, Milano, Italy

KENWOOD IBÉRICA S.A.

Bolivia, 239-08020 Barcelona, Spain

KENWOOD ELECTRONICS AUSTRALIA PTY. LTD.

(A.C.N. 001499 074)

P.O. Box 504, 8 Figtree Drive, Australia Centre, Homebush, N.S.W. 2140, Australia

KENWOOD & LEE ELECTRONICS, LTD.

Unit 3712-3724, Level 37, Tower 1, Metroplaza, 223 Hing Fong Road, Kwai Fong N.T., Hong Kong

KENWOOD ELECTRONICS GULF FZE

P.O. Box 61318, Jebel Ali, Dubai, U.A.E.

KENWOOD ELECTRONICS SINGAPORE PTE LTD.

No. 1 Genting Lane #02-02, KENWOOD Building, Singapore, 349544

KENWOOD ELECTRONICS (MALAYSIA) SDN BHD.

#4.01 Level 4, Wisma Academy Lot 4A, Jalan 19/1 46300 Petaling Jaya Selangor Darul Ehsan Malaysia

KENWOOD ELECTRONICS (THAILAND) CO., LTD.

573/111 Soi Ramkhamhaeng 39, Ramkhamhaeng Road, Wangthonglang, Bangkok, Bangkok 10301 Thailand